



Sheer
Driving Pleasure



Sheer
Driving Pleasure

04_2020_BS/1 BMW India Pvt. Ltd. Printed in India 2020.



THE X4

BMW EFFICIENT DYNAMICS.
LESS EMISSIONS. MORE DRIVING PLEASURE.

For more information, call 1800 102 2269.

The models, equipment and possible vehicle configurations illustrated in this brochure may differ from vehicles supplied in the Indian market. For precise information please contact your local BMW Authorised Dealer. Subject to change in design and equipment. © BMW India Pvt. Ltd., Gurgaon, India. Not to be reproduced wholly or in part without written permission of BMW India Pvt. Ltd., Gurgaon, India. [f/bmwindia](#) [You Tube/bmwindia](#) [t/bmwindia](#)

THE BMW X4

THE BMW X4.



DISCOVER MORE.



Scan the code to get more information,
more driving pleasure on the BMW X4.

INNOVATION AND TECHNOLOGY.



17 Dynamics and Efficiency
18 Drivetrain and Suspension



19 Safety
20 Comfort and Functionality

EQUIPMENT.

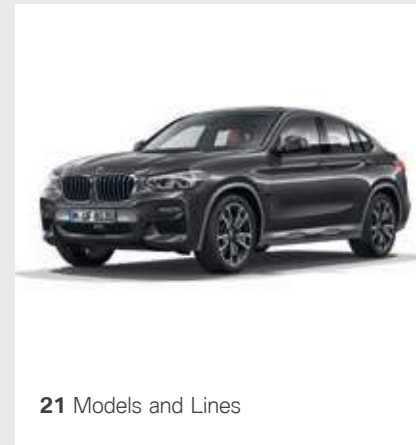

21 Models and Lines

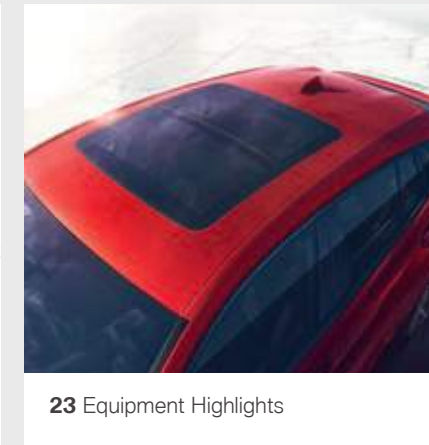

23 Equipment Highlights

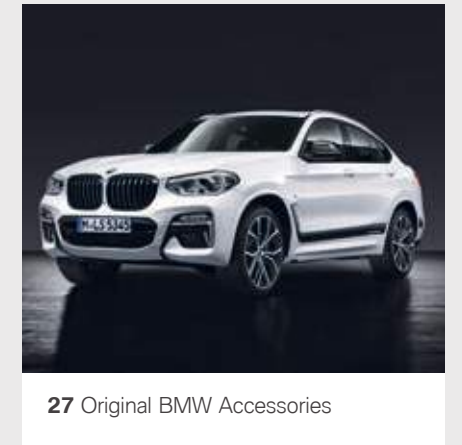

27 Original BMW Accessories



37 Exterior Colour

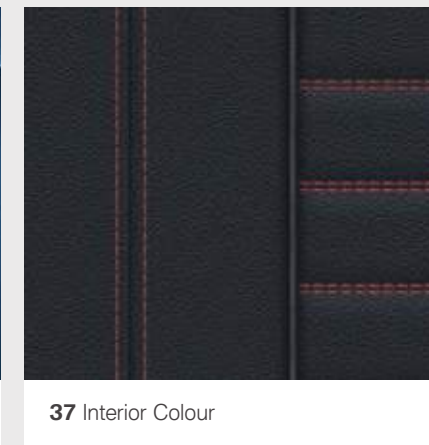

37 Interior Colour

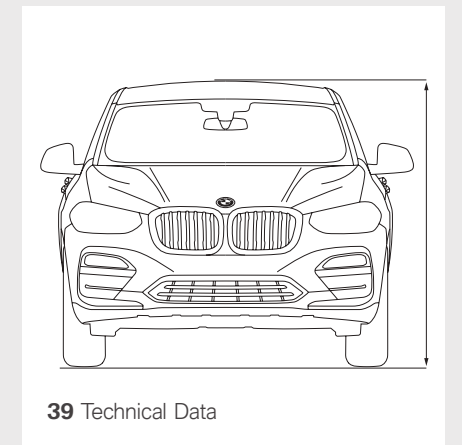

39 Technical Data

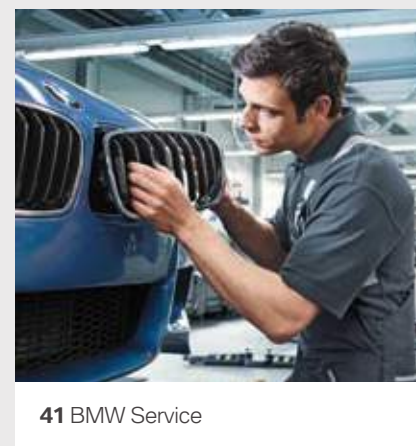

41 BMW Service

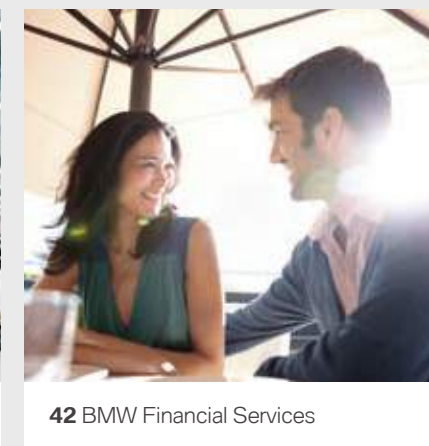

42 BMW Financial Services

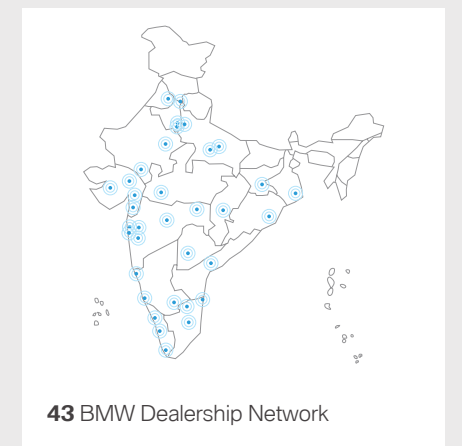

43 BMW Dealership Network

DYNAMICS
X DESIGN.



FULL
FORCE
AHEAD.





HIGH DESIGN,
HIGH SPEED.





PLACE OF RETREAT
FOR EXTROVERTS.



FINALLY SOMEONE
WHO UNDERSTANDS YOU.





THE MOST
BEAUTIFUL PLACE
IN TOWN.





BRING IT ON.
THE BMW X4.

SELF-ASSURED ATHLETIC EXTERIOR DESIGN SPORTY SILHOUETTE AND AERODYNAMIC KIDNEY GRILLE || FULL-LED FRONT HEADLIGHTS AND REAR LIGHTS || 19" LIGHT ALLOY WHEELS. **BRILLIANT PERFORMANCE** 50:50 WEIGHT DISTRIBUTION FOR IDEAL AGILITY || BMW xDRIVE. **INNOVATIVE ASSISTANCE SYSTEMS** PARKING ASSISTANT. **EASY CONNECTIVITY** 10.25" CONTROL DISPLAY WITH TOUCH CONTROL || GESTURE CONTROL || BMW HEAD-UP DISPLAY. **UNMISTAKABLY AESTHETIC INTERIOR DESIGN** LARGE PANORAMA GLASS ROOF || AMBIENT LIGHT IN THE INTERIOR AND EXTERIOR WITH WELCOME LIGHT CARPET. **EXPERIENCE ITS ATHLETICISM, DISCOVER ITS AESTHETICS. THE BMW X4.**

DYNAMICS AND EFFICIENCY.

BMW EFFICIENT DYNAMICS.
LESS EMISSIONS. MORE DRIVING PLEASURE.

MORE POWER FROM LESS FUEL.

More power from three to 12 cylinders. Consume less, experience more – the **BMW TwinPower Turbo engines** offer the greatest possible dynamic performance with the highest efficiency thanks to the latest injection systems, variable output control and sophisticated turbocharger technology. Whether diesel or petrol, and no matter how many cylinders, the engines from the BMW EfficientDynamics engine family allow markedly more agile power delivery and outstanding responsiveness even at low rpm, while being fuel-efficient and low in emissions.

MORE DRIVING PLEASURE, LESS EMISSIONS.

Approximately 33% less CO₂ emissions since 2000: **BMW EfficientDynamics** is a technology package that includes not only the drive, but rather the whole vehicle concept and intelligent energy management. Provided as standard in every BMW, a variety of innovative technologies contribute to continuously improving efficiency. Via engine efficiency measures, electrification, lightweight construction methods and optimised aerodynamics, BMW has managed to reduce the CO₂ emissions of its fleet by 33%.

MORE SPEED, LESS WEIGHT.

Lower weight with intelligent lightweight construction. Special consideration for every last detail – intelligent lightweight construction means that the optimal material is found and implemented for each part of the vehicle. With extremely light high-tech materials such as aluminium and carbon fibre, **BMW EfficientLightweight** is pursuing the goal of minimising vehicle weight. That leads to even more dynamic performance, increased stability and heightened vehicle safety and comfort.



AERODYNAMICS

With targeted measures focusing on aerodynamics, BMW has optimised the drag coefficient and efficiency as well as interior acoustics. Fuel consumption has also been reduced. The Active air stream kidney grille and the Air Curtain on the front wheels are targeted detailed measures to further reduce air resistance.

ACTIVE AIR STREAM KIDNEY GRILLE

The Active air stream kidney grille¹ represents the cutting edge of aerodynamic performance. When a cooling airflow is not needed, it electronically closes the radiator grille with its air vents and thereby reduces the amount of air flowing into the engine bay. This optimises both the aerodynamics and consumption rates.

DRIVING EXPERIENCE CONTROL INCL. ADAPTIVE MODE

The Driving Experience Control offers the driver the choice between the standard COMFORT mode, ECO PRO mode, geared towards efficiency, and SPORT mode, which enables even more dynamic driving. The new interactive function ADAPTIVE Mode continuously adjusts the Dynamic Damper Control, the steering and the Steptronic transmission to suit the current driving situation.

IN THE BMW X4.

¹ Available only in select variant.

DRIVETRAIN AND SUSPENSION.



ENGINE HIGHLIGHTS OF THE BMW X4.

BMW X4 xDrive20d

- BMW TwinPower Turbo four-cylinder diesel engine with 140kW (190hp) and 400Nm of torque
- Acceleration 0–100km/h: 8.0s
- Top speed: 213km/h
- Fuel economy km/l: 16.55¹
- CO₂ emissions g/km: 160.00¹

BMW X4 xDrive30d

- BMW TwinPower Turbo six-cylinder diesel engine with 195kW (265hp) and 620Nm of torque
- Acceleration 0–100km/h: 6.0s
- Top speed: 235km/h
- Fuel economy km/l: 14.71¹
- CO₂ emissions g/km: 180.00¹

BMW X4 xDrive30i

- BMW TwinPower Turbo four-cylinder petrol engine with 185kW (252hp) and 350Nm of torque
- Acceleration 0–100km/h: 6.3s
- Top speed: 213km/h
- Fuel economy km/l: 12.82¹
- CO₂ emissions g/km: 185.00¹

The **8-Speed Steptronic Sport Transmission** offers incredibly sporty gear changes. Whether automatic or manual using gearshift paddles or gear lever – for comfortable coasting or incredibly dynamic driving. In SPORT mode and with the gear lever in the left-hand S/M position, the gear shifts are configured for maximum performance.

The intelligent **BMW xDrive All-Wheel Drive System** smoothly and variably distributes drive power to the front and rear wheels for maximum traction, driving dynamics and safety in every driving situation. For even better agility, the electronically controlled power distribution for instance counterbalances oversteer or understeer on bends.

The **Adaptive Suspension** makes it possible to adjust the damper characteristics to suit any given driving situation, increasing comfort and driving dynamics. In addition to the standard COMFORT setting, for high driving comfort, there are two other programs available, SPORT and SPORT+, for an even sportier driving style.

Performance Control intervenes via engine control and through controlled braking of the drive wheels towards the inside of the bend. This distributes more drive power to the outer wheels. Directing the vehicle's angular momentum into the curve to boost agility and directional stability.

Dynamic Stability Control (DSC) permanently assesses the vehicle's movements and stabilises it using engine and braking regulation when unstable driving conditions are detected. Additional features of DSC are, for example, brake drying, braking readiness or the Hill-Start assistant, which holds the vehicle briefly in place when starting on inclines to prevent it from rolling backwards.

¹ Performance data as measured in the emission test done under controlled conditions of environment, driving cycle, fuel, etc. as specified in Rule 115 of Central Motor Vehicle Rules, 1989.

SAFETY.

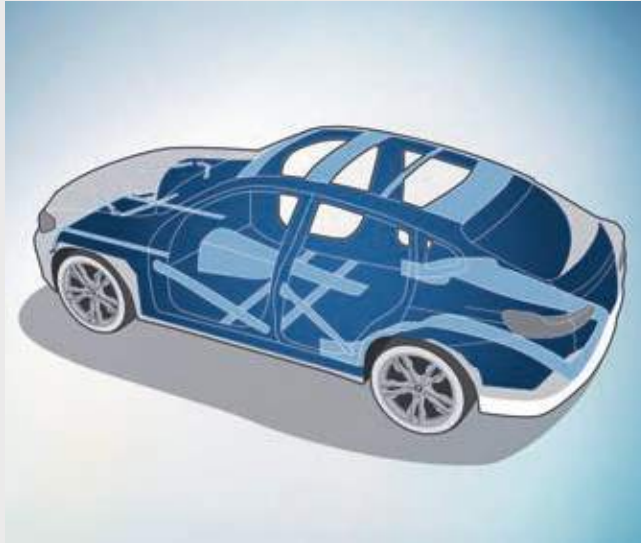

The functional structure of the **Passenger Cell** is composed of a specialised system of beams and nodal connections, featuring strategically deployed high-strength materials so as to deliver maximum passive safety in the event of front, side and rear collisions.

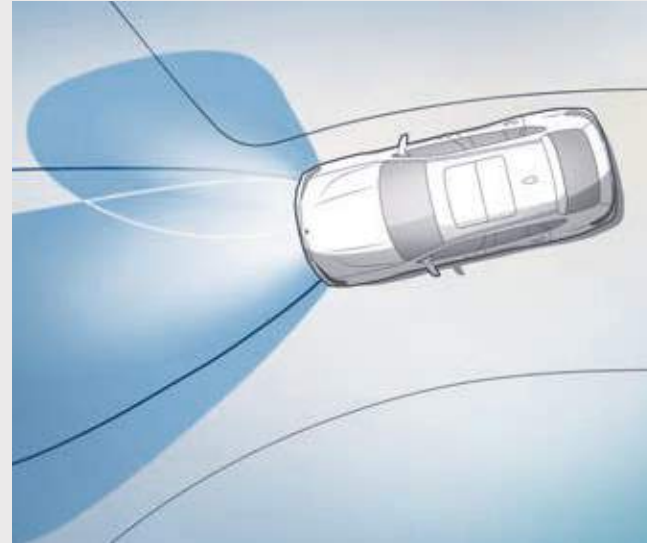

The **Adaptive LED Headlights** include low-beam and anti-dazzle high-beam headlights (BMW Selective Beam) and turn indicators with full LED technology. The equipment also features cornering lights, daytime running lights and Adaptive headlights with variable light control for excellent illumination of the road ahead and better visibility in the dark.

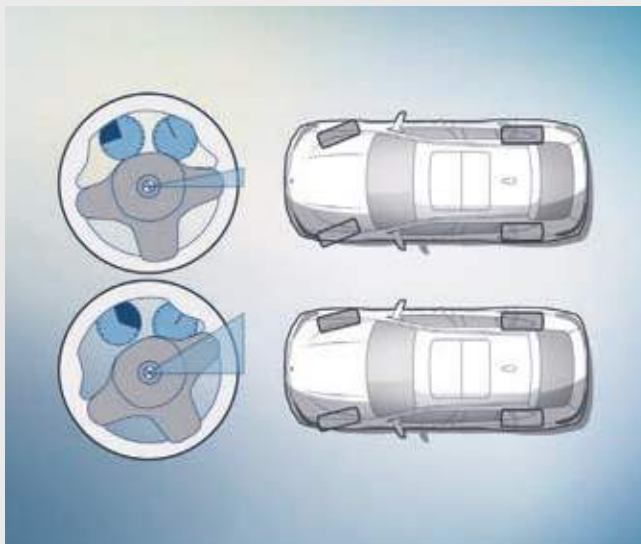

The **Variable Sport Steering** with Servotronic creates a direct and agile steering response and ensures that less physical effort is required to turn the wheel. It reacts to the angle of the steering wheel with varying steering ratios. This improves handling when driving more dynamically and reduces the effort needed to steer when parking and turning.

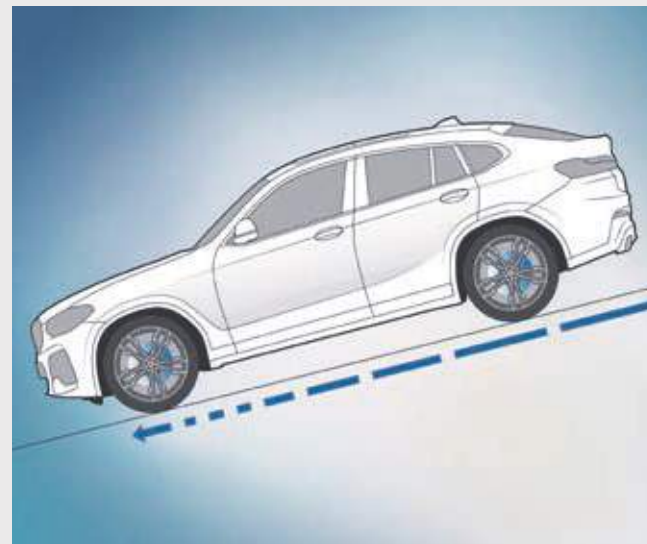

The **Hill Descent Control (HDC)** in the BMW X4 is a system which, when activated, ensures that the vehicle can master the steepest downhill runs automatically and safely at just above walking pace, without the driver having to brake.

COMFORT AND FUNCTIONALITY.



The **Acoustic Glazing** on the front side windows complements the acoustic glazing on the front windscreen and significantly reduces the level of noise for everyone inside the vehicle. It minimises noise created by the outside surroundings and flow of air, as well as by the engine, tyres and windscreen wipers. Music listeners and hands-free device users in particular will appreciate the difference this makes.

Ambient Light, Including Ambient Contour Lighting in the front and rear doors, creates a relaxed, cosy lighting atmosphere in the interior. The **Welcome Light Carpet** illuminates the area in front of the car doors when entering and exiting. Six dimmable light designs in White, Blue, Orange, Bronze, Lilac and Green are available.

When open, the **Panorama Glass Roof** provides a great deal of fresh air. Closed, it creates a bright, light-flooded atmosphere in the interior. It opens and closes completely automatically at the push of a button or with the car key, and is equipped with slide and lift functions, roller sunblind and wind deflector.

The **Storage Compartment Package** includes a hinged compartment in the front, nets on the back of the front seats, 12V sockets in the rear centre console incl. USB adapter and in the luggage compartment. The latter also contains hooks on the luggage compartment wall, a fastening strap, lashing rails on the luggage compartment floor and adjustable fastening points, a remote backrest unlocking and a cargo function for expanding the luggage compartment volume.

BMW X4 xDrive20d M Sport X

powered by 



Exterior Design:

- M Sport X exterior package with side skirts, wheel arch trim and rear apron with diffuser insert in Frozen Grey
- M Aerodynamics package with front apron in body colour
- LED fog lights
- 48.26 cm (19") M light alloy wheels Double-spoke style 698 M in Bicolor Ferric Grey gloss-lathed with run-flat properties
- M designation on the sides
- Exterior mirror caps in body colour
- Tailpipe trim strip in High-Gloss Chrome

Interior Design:

- M door sill finishers and M specific pedals
- Sport seats for driver and front passenger in Exclusive leather 'Vernasca'
- M Leather steering wheel with Multifunction
- BMW Individual headliner anthracite
- Fine wood trim "Fine line Cove" with highlight trim finisher in Chrome
- Car key with exclusive M designation
- M specific floor mats in velour
- Loading sill of the luggage compartment in stainless steel

Highlights:

- Adaptive LED headlights
- Variable sport steering
- Performance Control
- Adaptive Suspension
- Cruise Control with braking function
- Parking Assistant with Rear View Camera and Park Distance Control (PDC), front and rear
- Panoramic Glass Roof
- Ambient lighting with Welcome Carpet
- Auto operation of tailgate
- 3-zone automatic air conditioning
- BMW Live Cockpit Plus with 8.8" Screen and Touch Functionality
- Apple CarPlay®
- Wireless Charging
- Galvanic embellisher in Chrome
- Hi-Fi Loudspeaker



BMW X4 xDrive30d M Sport X BMW X4 xDrive30i M Sport X

powered by 



Exterior Design:

- M Sport X exterior package with side skirts, wheel arch trim and rear apron with diffuser insert in Frozen Grey
- M Aerodynamics package with front apron in body colour
- LED fog lights
- 48.26 cm (19") M light alloy wheels Double-spoke style 698 M in Bicolor Ferric Grey gloss-lathed with run-flat properties
- M designation on the sides
- Exterior mirror caps in body colour
- M Sport brake
- Tailpipe trim strip in High-Gloss Chrome

Interior Design:

- M door sill finishers, and M specific pedals
- Sport seats for driver and front passenger in Exclusive leather 'Vernasca'
- M Leather steering wheel with Multifunction
- BMW Individual headliner anthracite
- Interior trim finishers in Aluminium Dark Rhombicle with highlight trim finishers in Pearl Chrome
- Car key with exclusive M designation
- M specific floor mats in velour
- Loading sill of the luggage compartment in stainless steel

Highlights:

- Adaptive LED headlights
- Variable sport steering
- Performance Control
- Adaptive Suspension
- Cruise Control with braking function
- Parking Assistant with Rear View Camera and Park Distance Control (PDC), front and rear
- Panoramic Glass Roof
- Ambient lighting with Welcome Carpet
- Auto operation of tailgate
- 3-zone automatic air conditioning
- BMW Live Cockpit Professional with 10.25" screen and Touch Functionality
- Apple CarPlay®
- Wireless Charging
- Galvanic embellisher in Chrome
- Harman Kardon Surround Sound system
- Multifunctional instrument display
- Instrument Panel in Sensatec
- BMW Gesture control
- BMW Head-up Display





When open, the **Panorama Glass Roof** provides a great deal of fresh air. Closed, it creates a bright, light-flooded atmosphere in the interior. It opens and closes completely automatically at the push of a button or with the car key, and is equipped with slide and lift functions, roller sunblind and wind deflector.



Exclusive Galvanic Embellishers for controls such as the Start/Stop button, along with volume and temperature dials, lend a particularly high-quality look.



The **Instrument Panel and Door Panels in Sensatec** lend the interior of the vehicle a highly exclusive atmosphere.



The slight tinted **Heat/Sun Protection** glazing reflects infrared radiation to prevent the interior from heating up.

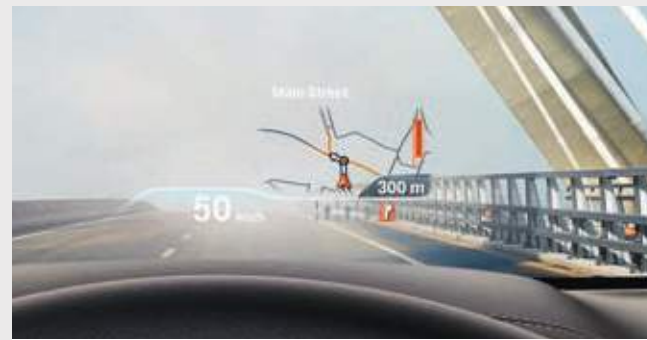

The full-colour **BMW Head-Up Display¹** projects all information relevant to the journey directly into the driver's field of vision.



Harman Kardon surround sound system with 600 watt digital amplifier, vehicle-specific equalising and loudspeakers with Chrome detailing.



Remote Backrest Unlocking for the rear seats allows the rear seat backrests to be unlocked and folded down conveniently via a lever in the luggage compartment.



The **8-Speed Steptronic Sport Transmission** offers incredibly sporty gear changes. Whether automatic or manual using gearshift paddles or gear lever.



The **Roof Rails** in Aluminium satinated provide the base for a multifunctional BMW roof rack unit.



The rear lights with lighting elements in LED technology consist of individual high-performance LED lighting elements and have the characteristic, striking BMW L-shape, meaning that the vehicle is clearly recognisable as a BMW even in the dark.



The **Storage Options**, including the storage compartment, encompass several storage spaces, including bottle holders and cupholders.

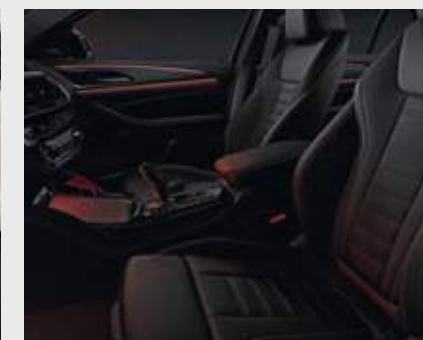

Ambient Light creates a relaxed lighting atmosphere, including ambient light accents and the Welcome Light Carpet.



The **Through-Loading System** with rear seat backrests, which are divisible in a 40:20:40 ratio, guarantees flexibility when transporting people and objects.

¹ The information in the BMW Head-Up Display is not fully visible when viewed through polarised sunglasses. Content shown will depend on the equipment options chosen. Further optional equipment is required to display specific items.



With **BMW Gesture Control**, certain functions can be operated by means of defined hand movements. For certain operations the system will for example recognise gestures such as swiping or pointing for accepting or rejecting an incoming call or circular motions of the index finger to adjust volume.



The newly developed interface design of BMW Live Cockpit Professional makes using the constantly expanding function of the infotainment system in the BMW X4 easier, more lucid and intuitive. The 26 cm (10.25") LCD display has Touch Functionality, configurable home screen, 3D Maps and can also be operated through iDrive Touch Controller and Voice Control.



Telephony with Wireless Charging¹ offers a comprehensive telephony package with Bluetooth connectivity.



The newly designed Instrument Display with Black Panel technology and a screen diagonal of 31.2 cm (12.3") provides a highly impressive visualisation of the driving experience. The different modes and their specific displays – each of which has its own colour scheme and graphic style – can be displayed in the instrument cluster.



Preparation for **Apple CarPlay^{2, 3}** supports the convenient and wireless use of selected iPhone® functions in the vehicle. This allows smartphone content and functions such as music, iMessages/text messages, telephony, Siri and selected third-party apps to be displayed and operated via the vehicle's user interface and via voice control.



The **Adaptive LED Headlights** include low-beam and high-beam headlights and turn indicators with full LED technology. The equipment also features BMW Selective Beam, cornering lights, daytime running lights and Adaptive headlights with variable light control for excellent illumination of the road ahead and better visibility in the dark.



The individually **Adjustable Sport Seats** for the driver and front passenger feature numerous manual adjustment options, including backrest width, fore-and-aft position, and the backrest and seat angle. Thanks to taller seat and backrest bolsters, and well-defined side bolsters, they provide excellent ergonomics and a high degree of lateral support.



Parking Assistant with Rear View Camera makes parking and manoeuvring the vehicle easier. The Parking Assistant with linear guidance parks the vehicle automatically, parallel or perpendicular to the street. If the driver parks manually without the help of the Parking Assistant, Active Park Distance Control (PDC) offers additional protection against damage with the Lateral parking aid.

¹ Inductive charging for Qi-compatible mobile phones is possible. Special charging cases are available from Original BMW Accessories for selected smartphones that do not support Qi inductive charging.

² Apps available on Apple CarPlay® is dependent on country specific offer by Apple.

³ The compatibility and range of functions from Apple CarPlay® depend on the model year and the software installed on the iPhone®. When the Apple CarPlay® preparation is used, selected vehicle data is transferred to the phone. The mobile phone manufacturer is responsible for further data processing.

ORIGINAL BMW ACCESSORIES.

AS A PROUD BMW OWNER, ACCESSORIES ARE CUSTOMISED TO YOUR OWN INDIVIDUAL TASTE. NOW YOU CAN FURTHER ENHANCE YOUR DRIVING PLEASURE WITH ORIGINAL BMW ACCESSORIES AND PERSONALISE YOUR BMW X4 FOR A GREATER LEVEL OF LUXURY. CHOOSE FROM OUR WIDE RANGE OF ACCESSORIES SPECIALLY DESIGNED FOR THE INTERIOR, EXTERIOR, ENTERTAINMENT, CONNECTIVITY, TRAVEL AND COMFORT TO SUIT YOUR INDIVIDUAL NEEDS.





M Performance Drive Analyser. The Drive Analyser comprises of an on-board diagnostics stick and a smartphone app to collect and analyse a variety of technical driving data.



M Performance Steering Wheel with Centre Mark. Thanks to its Alcantara-lined grip area the BMW M Performance steering wheel provides excellent feel and grip – for a more direct and responsive steering feel. Its distinctive design and centre band made of red leather underscore its motorsport style.



M Performance Alcantara Steering Wheel II with Carbon Trim. With an Alcantara cover for outstanding grip in even extreme driving situations and with a lacquered carbon trim. The steering wheel also has red marker at the 12 o'clock position.

M Performance Paddles, Carbon Fibre. The subtle difference: The M Performance paddles are covered with a very fine carbon fabric, finished in PUR paint and polished to a high gloss. The shift icons in M Red set additional motorsport highlights. Tiny details – fascinating impact.



M Performance Track Fix for Action Cameras. The M Performance Track Fix for Action cameras provides a safe and stable base for taking professional exterior shots while driving on the racetrack. The external mount is attached to one of the towing lugs. The camera can be controlled by means of an app.



Key Case, Alcantara/Carbon Fibre. The key case's material mix of carbon fibre and Alcantara is highly captivating. With accents in BMW M Blue.



Exterior Mirror Caps, Carbon Fibre. The striking carbon fibre exterior mirror caps underscore the vehicle's high-tech pedigree, adding an individual athletic touch.



M Performance Pedal Covers, Stainless Steel and Aluminium. Minimalist design, precise workmanship: Thanks to the asymmetrical design of the rubber treads, the solid stainless steel pedal covers give the footwell a distinctively dynamic high-tech look. A perfect complement to other BMW M Performance Parts.



M Performance Floor Mats, Front and Rear. No compromises, not even in the footwells. The BMW M Performance floor mats perfectly round out the upscale, dynamic appearance of the car's interior. Premium look. Optimal traction.

WHEELS AND TYRES.



21" M Performance forged wheel Y-spoke style 701 M in Bicolor Jet Black matt, gloss-lathed, lends the vehicle a very sporty appearance with its exclusive look. Front: 8.5J x 21. Rear: 9.5J x 21.



20" M light alloy wheels Double-spoke style 699 M in Bicolor Orbit Grey, bright turned, with mixed tyres, front 8J x 20 with 245/45 R20 tyres, rear 9.5J x 20 with 275/40 R20 tyres.



20" light alloy wheels Y-spoke style 695 Orbit Grey bright turned with mixed tyres, front 8J x 20 with 245/45 R20 tyres, rear 9.5J x 20 with 275/40 R20 tyres.



20" light alloy wheels Y-spoke style 695 in matt Jet Black, front 8J x 20 with 245/45 R20 tyres, rear 9.5J x 20 with 275/40 R20 tyres.



19" M light alloy wheel Double-spoke style 698 M in Orbit Grey lends the vehicle a very sporty appearance with its exclusive look. 7.5J x 19.

UNIVERSAL ACCESSORIES.



LED Door Projectors. The innovative door projectors are automatically activated when the doors are opened. They project an image onto the ground next to the car using an interchangeable slide.



Tyre Mobility Set. With the intuitive BMW Mobility Set, damage on the tyre tread of less than 4 mm can be fixed. The set comprises a powerful compressor, tyre sealant, gloves and various valve adapters that can also be used.



Fitted Luggage Compartment Mat. The anti-slip, waterproof and durable mat with a border helps protect the luggage compartment.



Advanced Car Eye 2.0. A highly sensitive full-HD camera that captures events in front of and behind the car, even when it is parked. In the event of disturbances and extraordinary movement outside the vehicle, the camera automatically records the situation in order to document possible accidents or (attempted) break-ins.



Floor Mat. The perfectly fitted, durable all-weather floor mats with raised border and elegant design protect the front and rear footwell from moisture and dirt. They are black and feature a black inlay.



Child Seat Underlay and Backrest Cover. Foam padding made of high-quality, robust polyester fabric to protect the seat from soiling and pressure marks. Wipe with a damp cloth to clean. Including backrest cover. Quick and stable attachment.



Travel & Comfort System – Universal Hook.¹ The universal hook makes it possible to hang items of clothing or light bags on the rear side of the backrest, protecting them from dirt in the footwell.



BMW Leather Key Case. The perfectly fitted key case, made from high-quality leather, is fixed to the key with a stylish metal clasp. It protects against scratches, dirt and moisture and protects buttons from accidental usage.



Travel & Comfort System – Universal Cradle.¹



Travel & Comfort System – Folding Table.¹



BMW Baby Seat Group 0+. The BMW Baby Seat Group 0+ with a five-point belt offers unsurpassed safety and comfort for babies up to approx. 13 kg (approx. 15 months old).



BMW Junior Seat Group 1. The BMW Junior Seat Group 1 is the safe choice for children from approx. 12 months to 4 years old (approx. 9–18 kg).



Travel & Comfort System – Base Carrier. Provides an option to attach clothes hangers, a folding table, universal hooks or holders for GoPro cameras, iPads™ or Samsung Galaxy Tabs to the front seat headrest.



Travel & Comfort System – Clothes Hanger.¹ The Travel & Comfort System clothes hanger in an attractive BMW design makes it possible to hang pieces of clothing on the rear side of the backrest.



BMW Junior Seat Group 2/3. The BMW Junior Seat Group 2/3 can be adjusted as the child grows and offers maximum safety and comfort for children aged approx. 3 to 12 years (approx. 15–36 kg).



The Travel Set. Includes a carry-on sized trolley suitcase and a carry bag that helps to create extra storage space in the rear seat. The luggage can be transported individually or stacked and secured with the safety belts. This feature locks to prevent theft.

¹ Only in conjunction with base carrier.

THE ART
OF CAR CARE.



BMW Car Care Products are the BMW approved car cleaning products. Designed to keep your BMW in mint condition from the interior as well as the exterior. They also provide a protective shield against environmental conditions and preserve the high-quality finish of your vehicle.

EXTERIOR COLOURS.



Non-metallic
Alpine White



Metallic
Flamenco Red
Brilliant Effect



Metallic
Phytotic Blue



Metallic
Carbon Black

INTERIOR COLOURS.

LEATHER



Leather 'Vernasca'
Canberra Beige with decorative stitching, interior colour Black

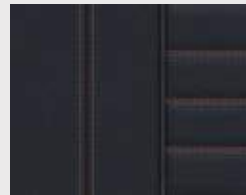

Leather 'Vernasca'
Black, contrast stitching Red, interior colour Black²

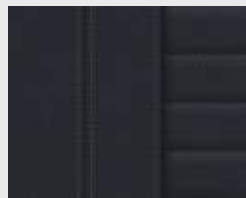

Leather 'Vernasca'
Black with decorative stitching, interior colour Black¹



Leather 'Vernasca'
Cognac with decorative stitching, interior colour Black

INTERIOR TRIMS



Fine-wood trim 'Fineline' Cove with highlight trim finisher Pearl Chrome¹

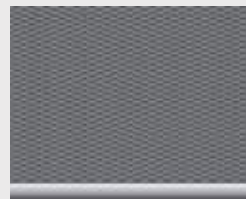

Interior trim finishers Aluminium Rhombicle dark with highlight trim finisher Pearl Chrome²

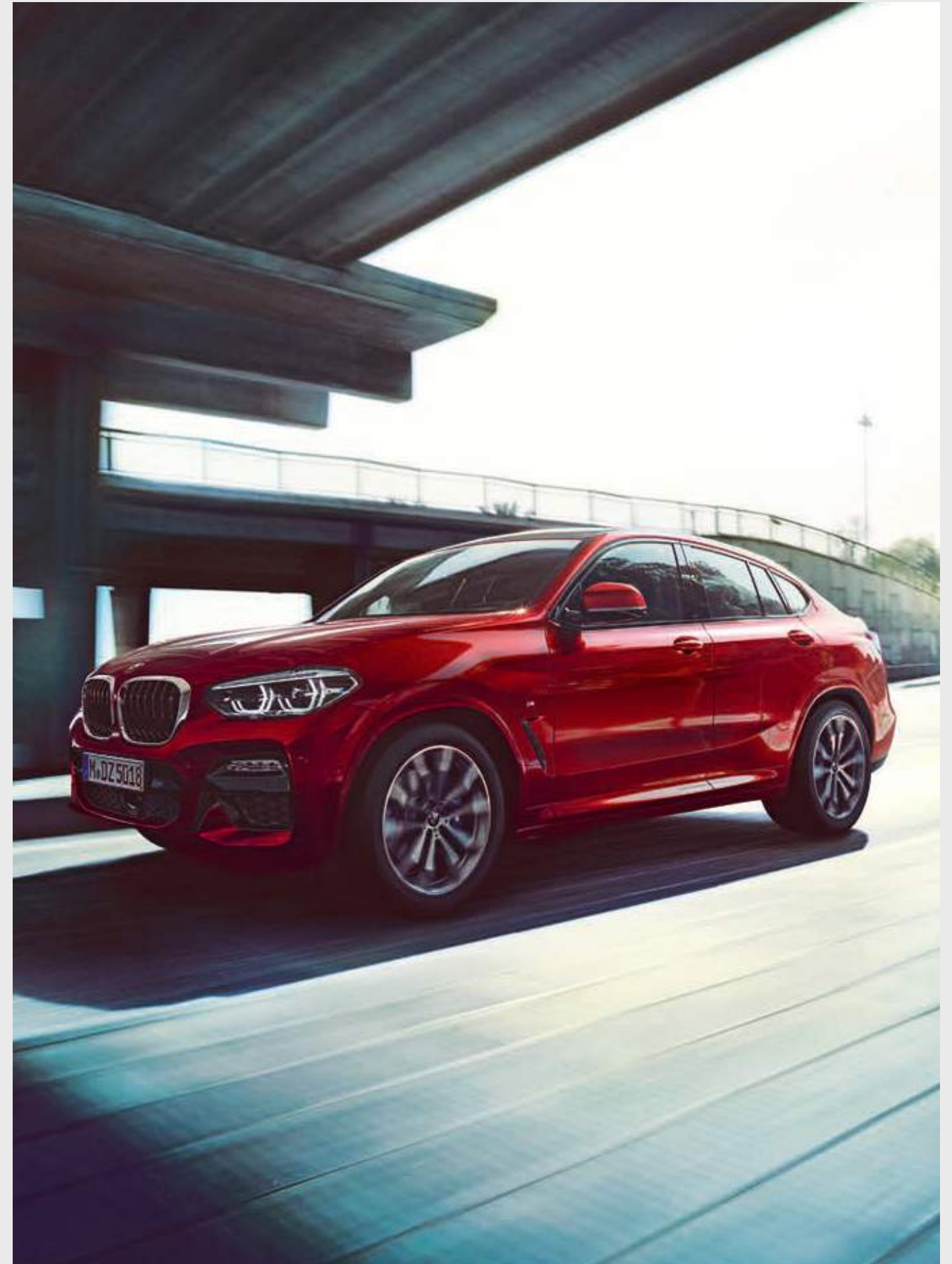

Please note that even normal long or short-term use can lead to permanent upholstery damage. This can be caused in particular by non-colourfast clothing. The interior colour is dependent on the chosen upholstery colour.

¹ Only available with BMW X4 xDrive20d M Sport X.
² Only available with BMW X4 xDrive30d/30i M Sport X.

DIMENSIONS.

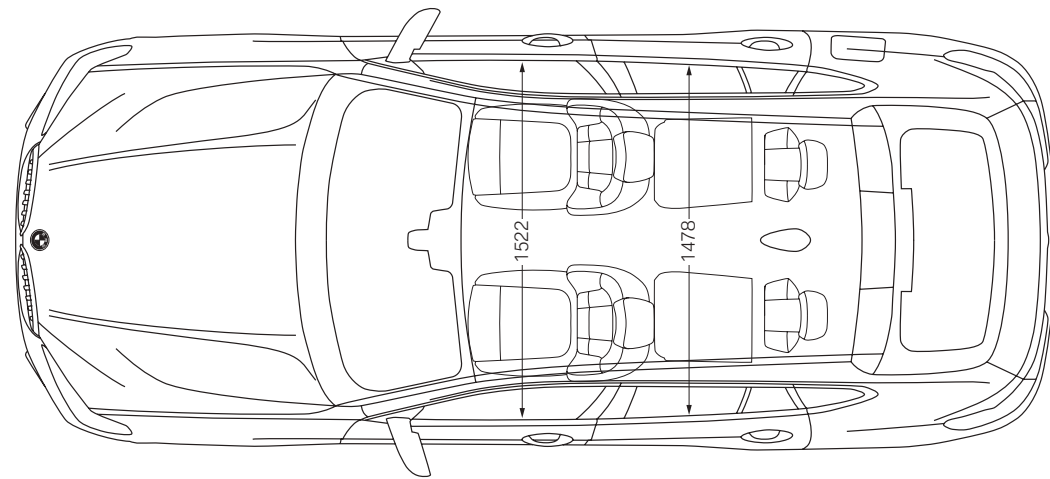
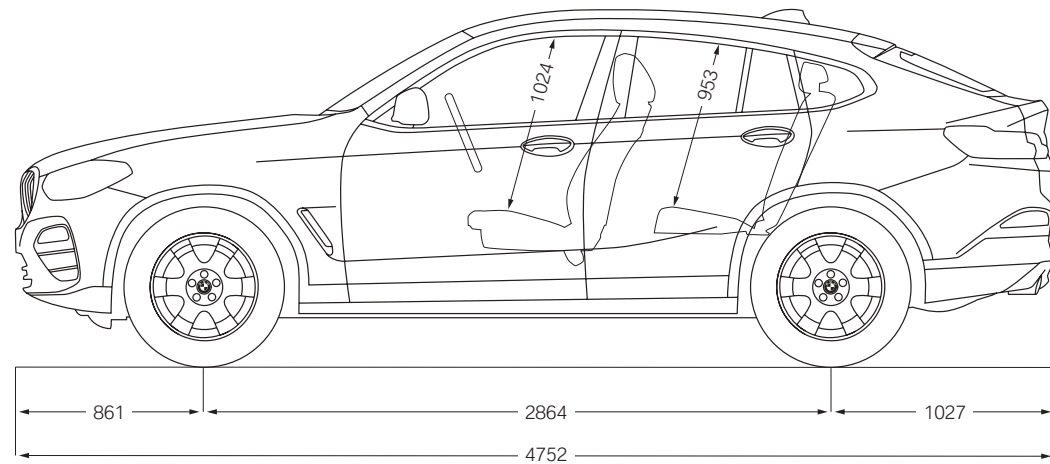
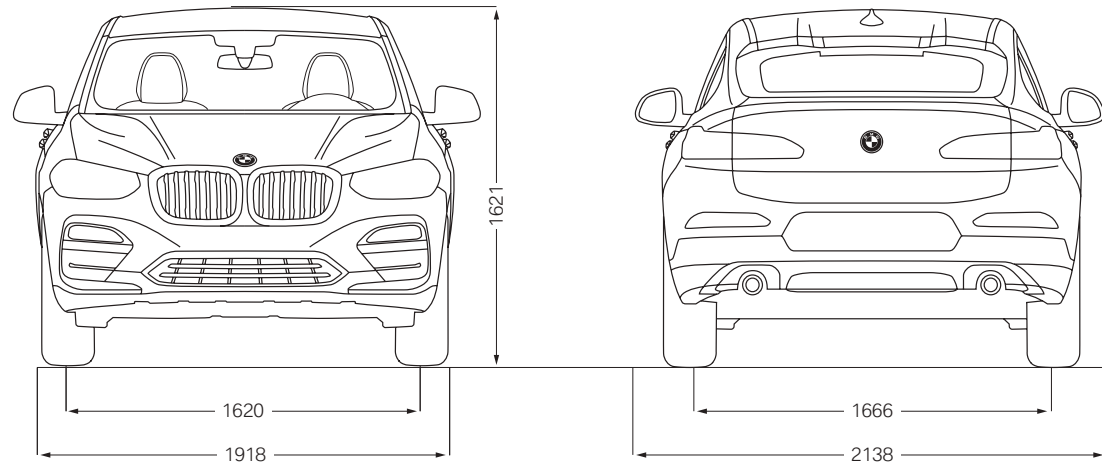

BMW EXTENDED WARRANTY AND SERVICE PACKAGES.



A BMW will run well when it's kept well. And to make your journey one with complete peace of mind, we have packages under BMW Service and Repair Inclusive that take care of maintenance, inspection, wear and tear and warranty.

BMW Service Inclusive (BSI)

A single up-front payment covers an extensive range of work on your BMW for a fixed period.

Complete Cost Control.²

Integrate the cost of service work in your leasing and finance installments.

Fully Flexible.

You have a choice of various packages with different durations and mileage. You can choose from 3 years with 40,000 km to 10 years with 2,00,000 km.

Easily Transferable.

Consistent maintenance by trained BMW Service staff and the use of Original BMW Parts secure the value of your car in the long term. In case you sell your car, BMW Service Inclusive is automatically transferred to the next owner – an additional selling point.

BMW Repair Inclusive (BRI)

BRI offers the ease of extending the warranty of your car with unlimited mileage up to 6 years.

BRI too is automatically transferred to the next owner in the event of selling your car.

Service Inclusive Packages		Oil Inclusive	Service Inclusive Basic	Service Inclusive Plus	Repair Inclusive
Scope of Services		Maintenance Engine oil service.	Maintenance All maintenance work, including any BMW Original Parts and oil required.	Wear and Tear Additional wear and tear repairs including any Original BMW Parts required.	Repair Extension of your statutory right to claim for vehicle defects (warranty).
Maintenance	Engine oil service	✓	✓	✓	
	Engine oil top ups		✓	✓	
	Vehicle check and standard scopes		✓	✓	
	Service/replace air filter		✓	✓	
	Service/replace fuel filter		✓	✓	
	Service/replace micro filter		✓	✓	
	Service/replace spark plugs		✓	✓	
Service/replace brake fluid		✓	✓		
Wear & Tear	Replacement of front/rear brake pads			✓	
	Replacement of front/rear brake discs			✓	
	Replacement of clutch (if necessary)			✓	
	Replacement of wiper blades (once in a year)			✓	
Extension of your statutory right to claim for vehicle defects (warranty) ¹					✓

BMW FINANCIAL SERVICES.

BMW Financial Services
Realize the dream.



In the world of BMW, world-class isn't limited to the vehicles we engineer. It also finds its way into the services we offer. BMW Financial Services is the most flexible and efficient way to realise your dream of owning a BMW. Our goal is to make your financing experience seamless at every step of your purchase so that nothing comes between you and the joy of driving your BMW.

At BMW Financial Services, you are assured of:

- Tailor-made finance options, as per your specific needs
- Quick approvals with fast turnaround time
- Special loyalty benefits
- Part payment facility
- In-house call centre that provides the best-in-class customer interaction

The BMW X4 comes with an exclusive BMW 360° Plan. It has benefits at every step of the way, all to ensure sheer driving pleasure.

Easy to Buy.

The BMW 360° Plan allows you to pay low monthly installments as you only pay for what you use.

Easy to Own.

BMW offers various options under service and maintenance packages which further reduce your cost of ownership.

Future Proof.

The BMW 360° Plan provides Assured Buyback value at the end of your finance contract.

For more information, contact the Finance and Insurance Manager at the nearest BMW Authorised Dealership.

¹ Terms and conditions apply.

² Applicable only with BMW India Financial Services Private Limited during the initial purchase of the vehicle (not on other finance options or during upgrades).

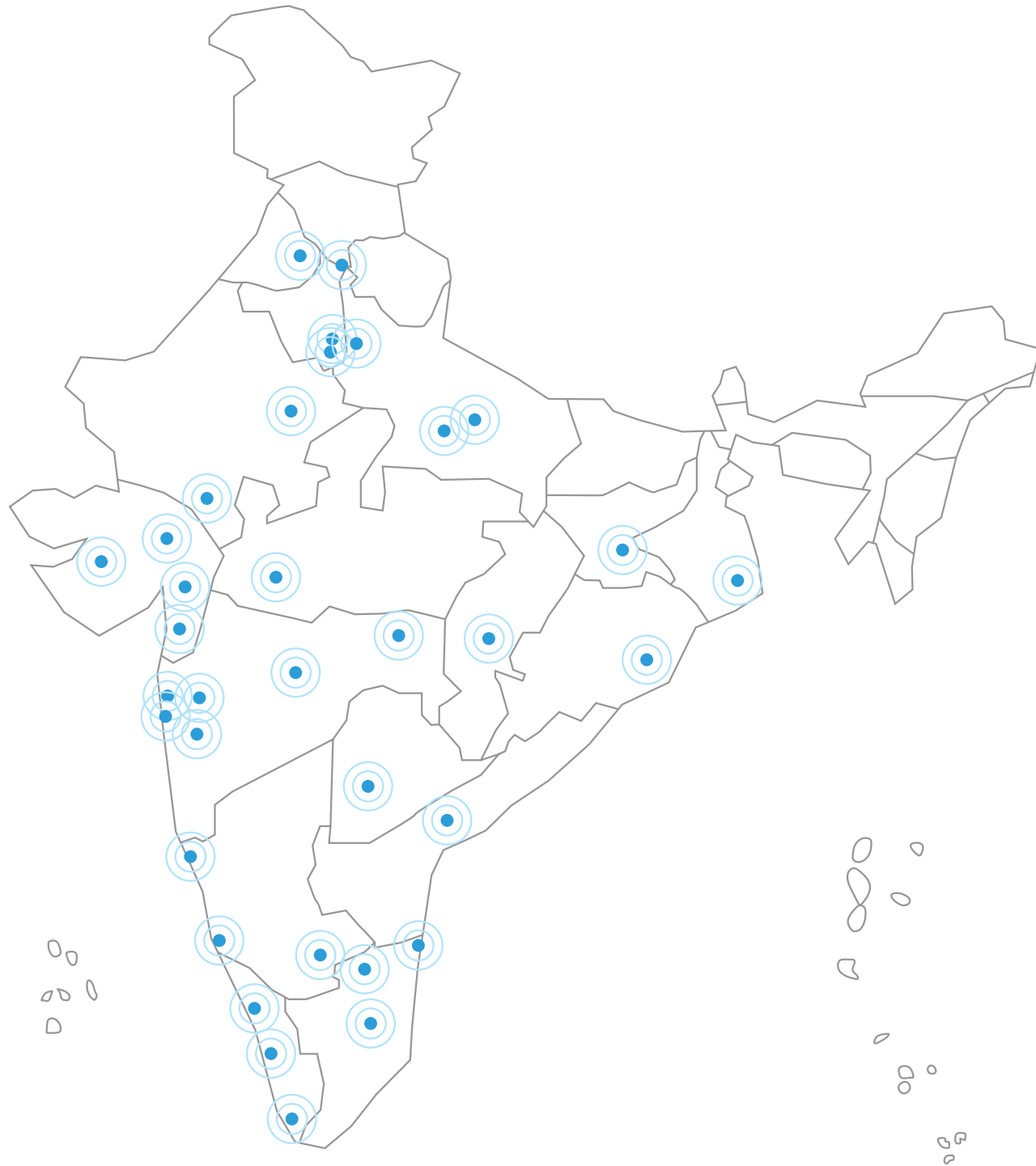

The pictorial representation does not purport to be the political map of India.

NORTH

BMW Bird Automotive

- SW 4IDC, MG Road, Gurugram
- S Golf Course Road, Sector 56, Gurugram

BMW Deutsche Motoren

- S Mohan Cooperative, Mathura Road, New Delhi
- W Shivaji Marg, Moti Nagar, New Delhi
- SW Sector 27B, Mathura Road, Faridabad
- S Sector 63, Noida

BMW Infinity Cars

- S Rajouri Garden, New Delhi
- W Mayapuri, New Delhi

BMW Krishna Automobiles

- SW Industrial Phase 1, Chandigarh
- SW GT Road, Ludhiana

BMW Sanghi Classic

- SW Tonk Road, Jaipur
- S Madri Industrial Area, Udaipur

BMW Speed Motorwagen

- SW Chinhat, Lucknow
- SW Kalpi Road, Kanpur

EAST

BMW OSL Prestige

- S Silver Arcade, Kolkata
- W East Topsia Road, Kolkata
- SW Bhanpur, Cuttack

BMW Titanium Autos

- SW Ormanjhi, Ranchi

WEST

BMW Bavaria Motors

- S Wellesley Road, Pune
- W Hadapsar, Pune
- SW Verna, Goa
- SW Chikalthana, Aurangabad

BMW Eminent Cars

- SW Surat-Dumas Road, Piplod, Surat
- SW Sunpharma Road, Vadodara

BMW Gallops Autohaus

- SW S G Highway, Sarkhej, Ahmedabad
- S Gondal Road, Rajkot
- W AJI GIDC, AJI Crossroads, Rajkot

BMW Infinity Cars

- S Worli, Mumbai
- S Nariman Point, Mumbai
- S Vashi, Navi Mumbai
- W Lalbaug, Mumbai
- W Worli, Mumbai
- W Turbhe, Navi Mumbai
- SW Dewas Naka, Indore

BMW Munich Motors

- SW Sarona, Raipur
- SW Hingna MIDC, Nagpur

BMW Navnit Motors

- S Juhu, Mumbai
- S Malad, Mumbai
- W Andheri, Mumbai
- W Gokul Nagar, Thane

SOUTH

BMW Deutsche Motoren

- S Whitefield, Bengaluru
- W Whitefield, Bengaluru

BMW EVM Autokraft

- SW Kalamassery, Kochi
- W Puthiyangadi, Calicut
- W Kochuveli, Trivandrum

BMW KUN Exclusive

- S Khairtabad, Hyderabad
- W RTC, Cross Road, Hyderabad
- SW Mangalagiri, Vijayawada

BMW KUN Exclusive

- SW Meenambakkam, Chennai
- S EA Mall, Chennai
- S Ambattur, Chennai
- W Ambattur, Chennai
- SW Avinashi Road, Coimbatore
- SW Virudhunagar, Madurai

BMW Navnit Motors

- S Lavelle Road, Bengaluru
- W Bethahalasoor Post, Bengaluru
- SW Hosur Road, Bengaluru
- SW Kodikal, Mangaluru

SW Showroom and Workshop S Showroom W Workshop

SEARCH



Scan to visit the BMW Online Shop